

Standard Dimensions:x

The following are standard dimensions unless otherwise stated.

All dimensions subject to commercial tolerance.

- Hole Size: 14mm diameter
- Hole Spacing (From End): 20mm from end of fitting
- Hole spacing (On Center): 48mm center to center
- Fitting Width: 40mm

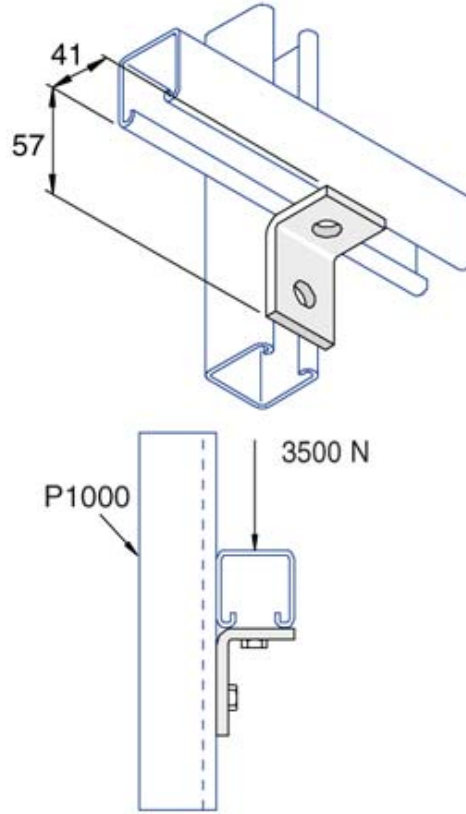

Part No.	Finish	Weight	Box Qty
P1068	HG	0.13	25
P1068	SS	0.13	25

Project: _____
 Architect / Engineer: _____
 Date: _____ Phone: _____
 Contractor: _____
 Address: _____

 Notes 1: _____

Approval Stamp: