

Standard Dimensions:x

The following are standard dimensions unless otherwise stated.

All dimensions subject to commercial tolerance.

- Hole Size: 14mm diameter
- Hole Spacing (From End): 20mm from end of fitting
- Hole spacing (On Center): 48mm center to center
- Fitting Width: 40mm

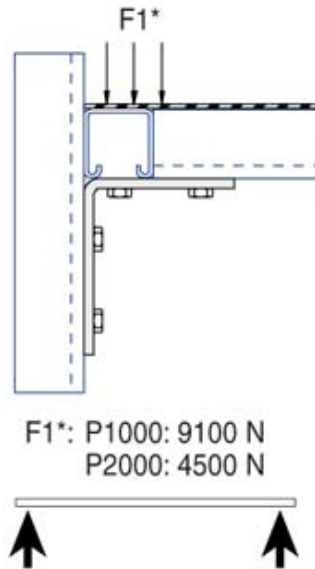
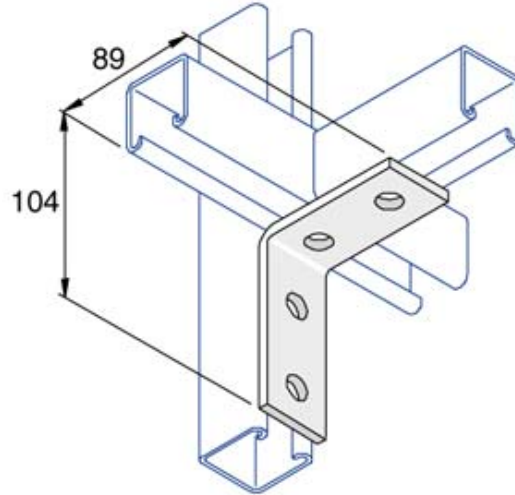

Part No.	Finish	Weight	Box Qty
P1325	HG	0.26	25
P1325	SS	0.26	25

Project: _____

Architect / Engineer: _____

Date: _____ Phone: _____

Contractor: _____

Address: _____

Notes 1: _____

Approval Stamp: